

NASIENRIGLYNE

EKSAMEN	NASIONALE SENIOR SERTIFIKAAT
DATUM	2024
VAK	INGENIEURSGRAFIKA EN -ONTWERP
VRAESTEL	1
PUNTE	100
TYD	3 Ure
AANTAL BLADSYE	7



SOUTH AFRICAN COMPREHENSIVE ASSESSMENT INSTITUTE
SUID-AFRIKAANSE KOMPREENSIEWE ASSESSERINGSINSTITUUT

FINALE GOEDGEKEURDE NASIENRIGLYNE

VERGADERINGSDATUM	
UMALUSI MODERATOR	
HOOFNASIENER	
INTERNE MODERATOR	

ANTWOORDE		
1	2024/01/10✓	1
2	KIMBERLEY✓	1
3	CASIO KONSTRUKSIE✓	1
4	2✓	1
5	2023/11/23✓	1
6	ASFALT✓	1
7	13✓	1
8	3,5✓	1
9	1 : 40✓	1
10	MOET VERWYDER WORD✓	1
11	INSPEKSIEKAMER✓	1
12	RIGTING VAN VLOEI✓	1
13	SO✓	1
14	SKUIF-/ OOPMAAKRIGTING✓	1
15	VOORGESTELDE KANTOORGEBOU STEEK VERBY BOULYN✓✓	2
16	$(6 \times 2,5) \times 9 = 135 \text{ m}^2$ ✓✓	2
17	NOORDWES/ NW✓✓	2
18	SIEN ANTWOORD 18, 19 & 20 HIERONDER.	3
19		3
20		4
TOTAAL:		30

ANTWOORD 18

$$2(15 + 4) + 2(15 + 5)✓$$

$$= 78✓$$

(in meter✓)

ANTWOORD 19

$$(10 \times 15) + (25 \times 26) + 117✓$$

$$= 917✓\text{m}^2✓$$

ANTWOORD 20



GROOT REGHOEK 1
 KLEIN REGHOEK 1
 VERDEELLYN ½
 DREINEERGATE 1
 VRYHAND ½

 4

VRAESTEL 1 VRAAG 2
SACAI NSS EKSAMEN
NASIENRIGLYNE

ASSESSERINGSKRITERIA	
1	VOORAANSIG 7
2	DEURSNEE BOAANSIG 17 ½
3	REGTERAANSIG 12 ½
TOTAAL: 37	

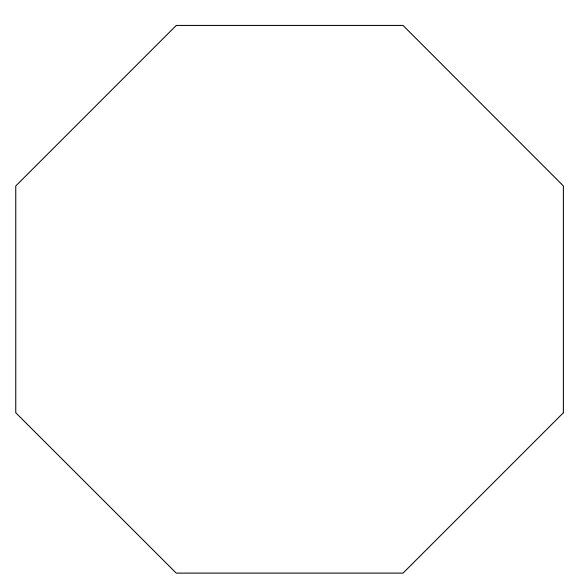
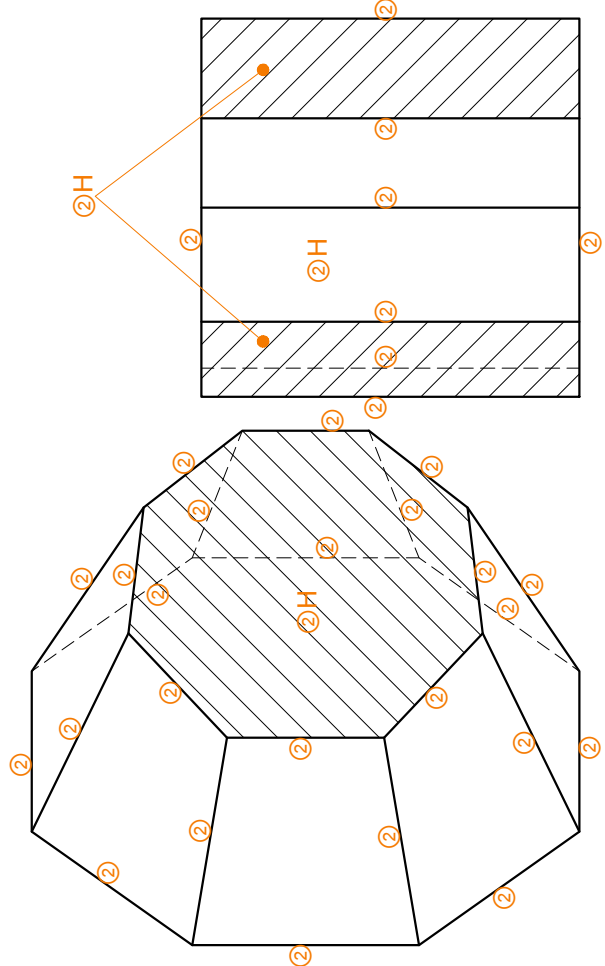
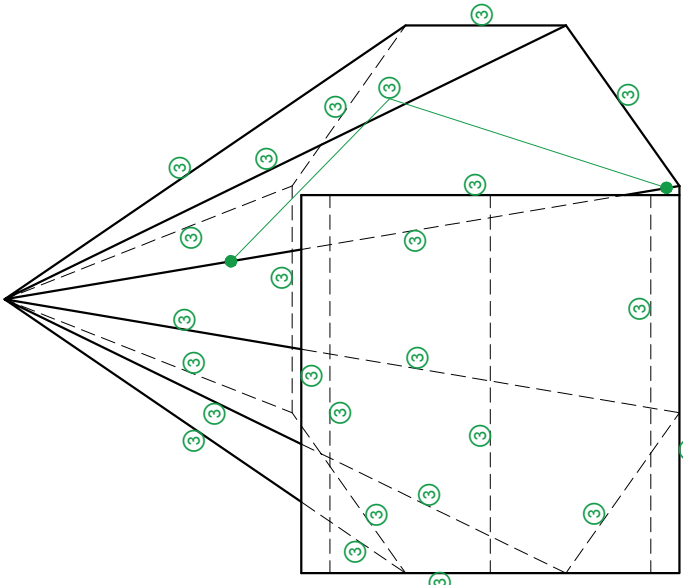
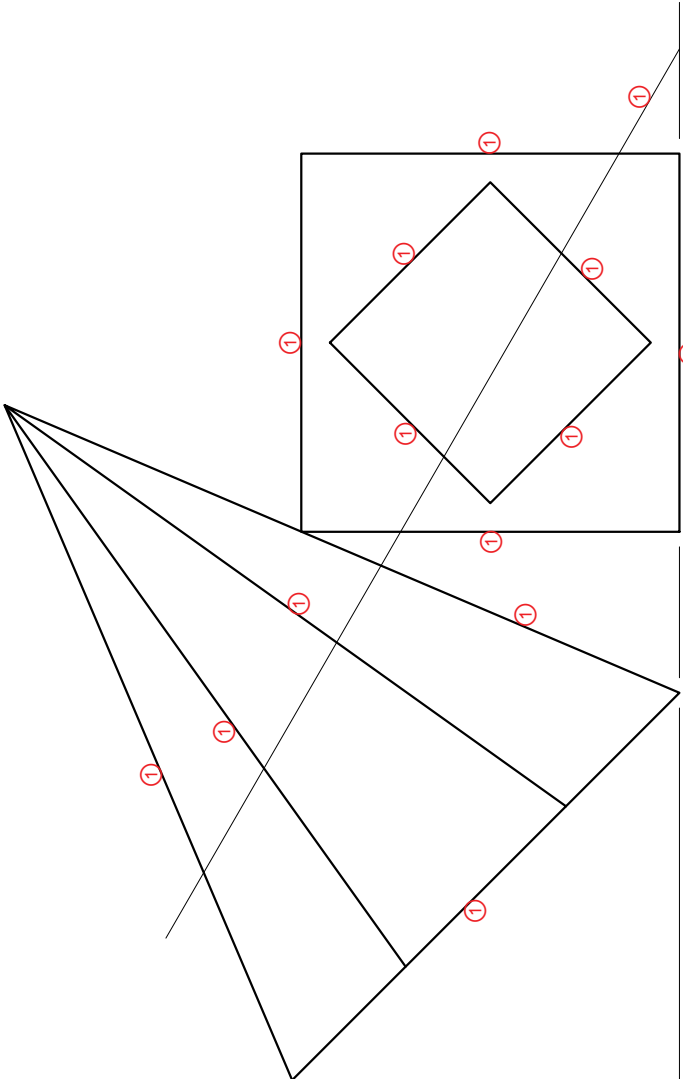

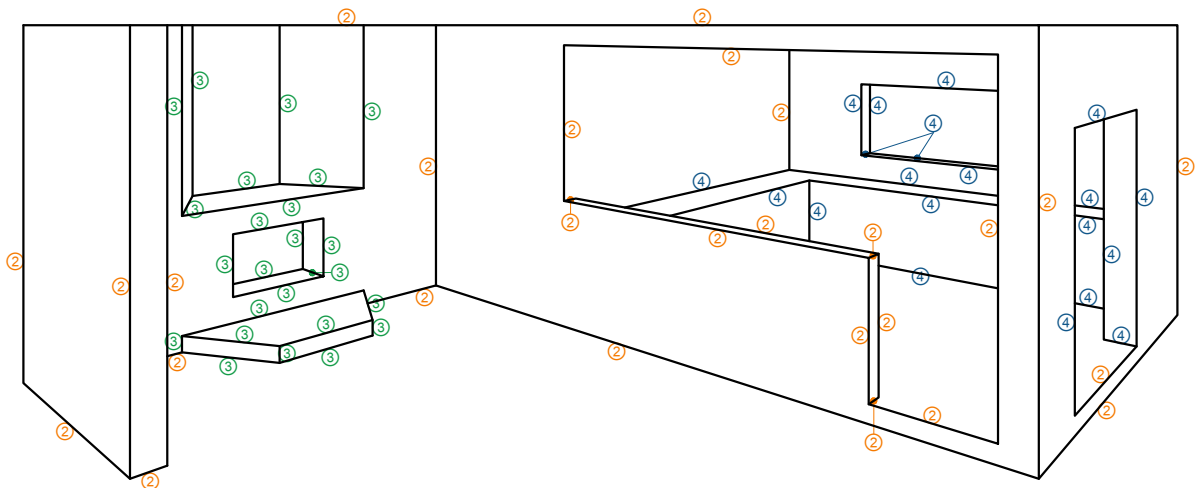
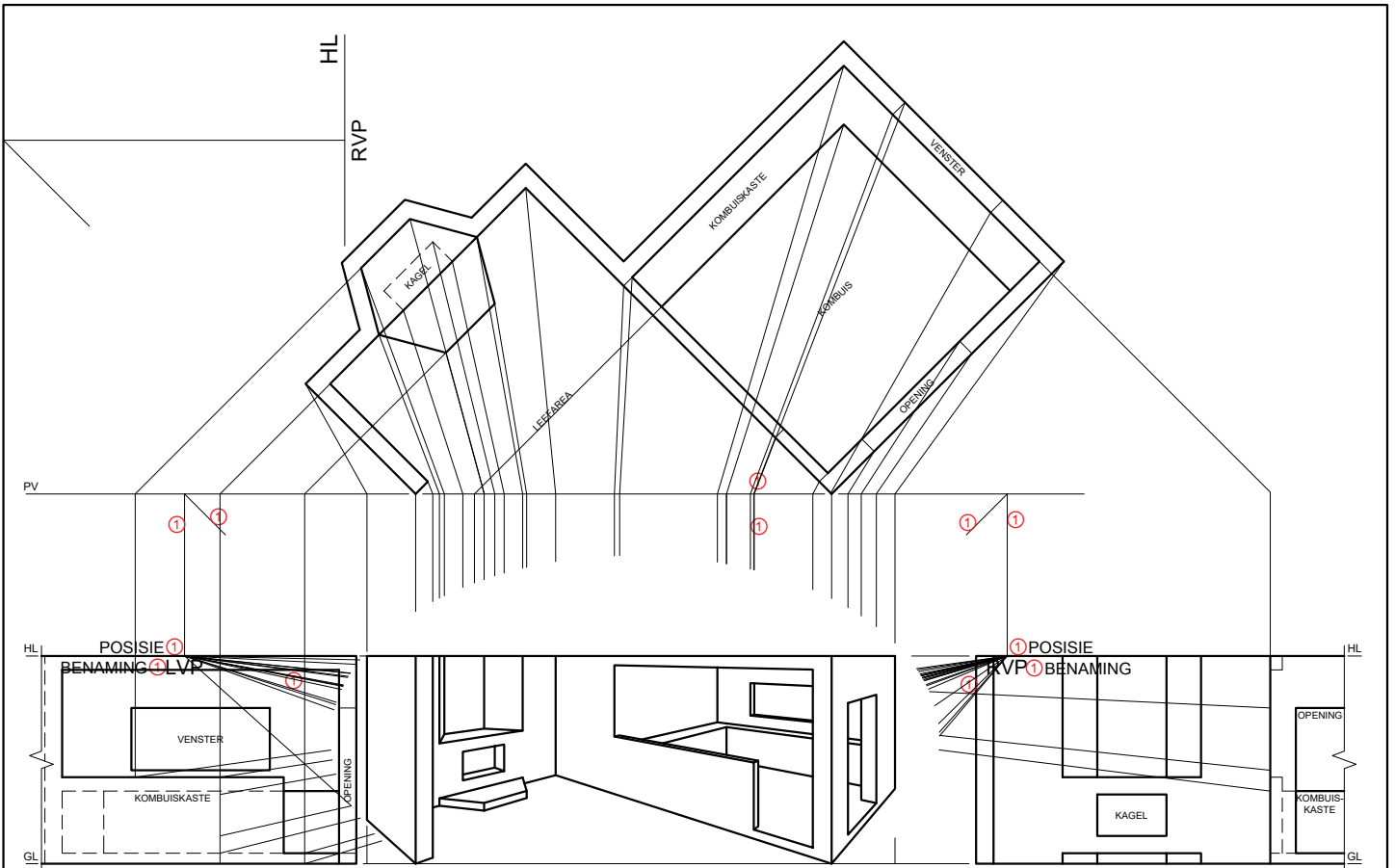

VRAESTEL 1 VRAAG 3
SACAI NSS EKSAMEN
NASIENRIGLYNE

ASSESSERINGSKRITERIA		
1	KONSTRUKSIE & VP'E	6
2	VLOER + MURE + TRAP	13 ½
3	KAGGEL	12
4	VENSTER + OPENING + KASTE	9 ½
TOTAAL:		41

VRAESTEL 1 VRAAG 4.1.1
SACAI NSS EKSAMEN
NASIENRIGLYNE

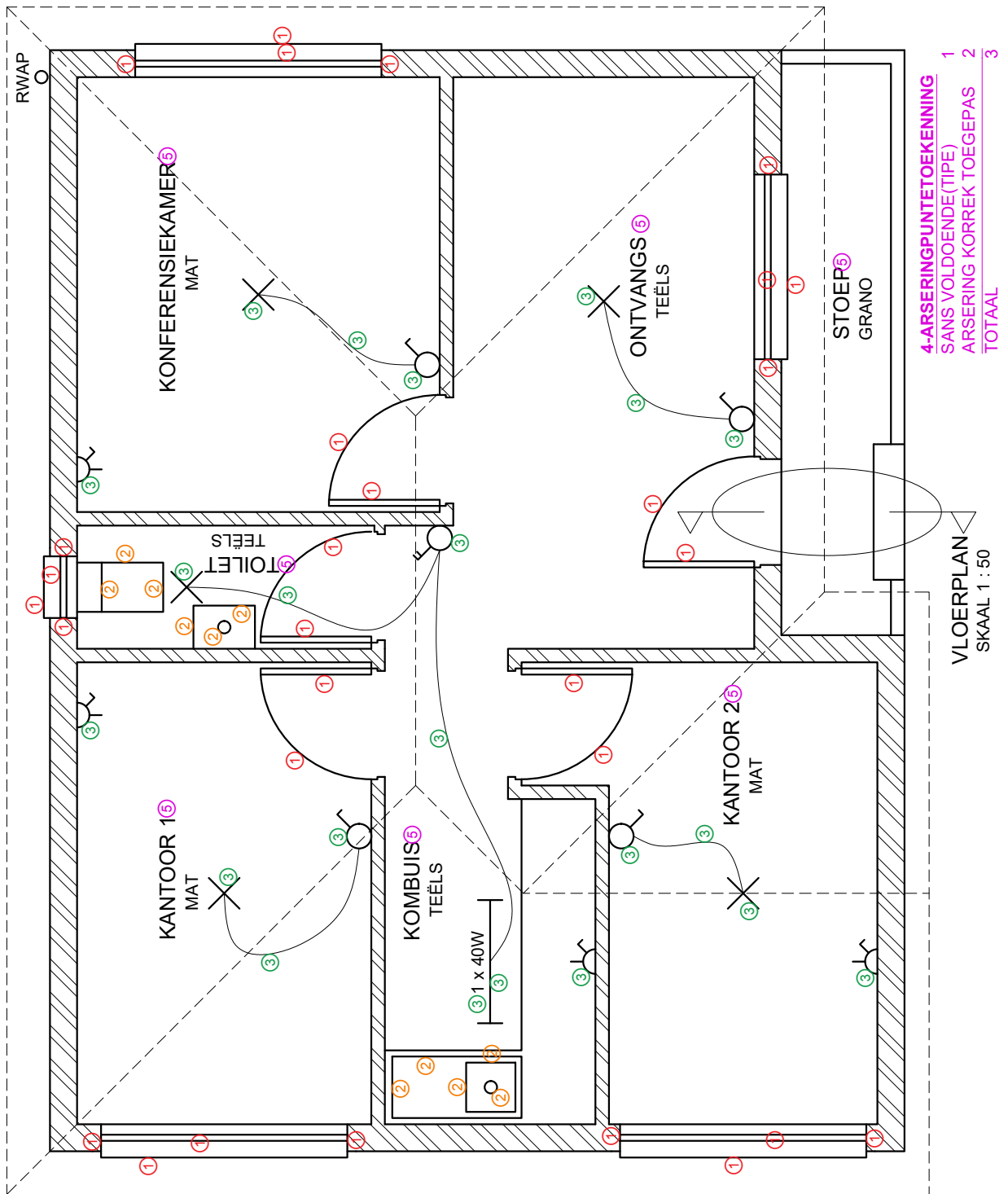

ASSESSERINGSKRITERIA		
VLOERPLAN		
1	VENSTERS + DEURE	15
2	TOEBEHORE	5½
3	ELEKTRIES	11
4	ARSERING	3
5	BYSKRIFTE	3½
SUBTOTAAL:		38

4-ARSERINGPUNTOEKENNING
SANS VOLDOENDE(TIPE) 1
ARSERING KORREK TOEGEPAS 2
TOTAAL 3

VLOERPLAN
SKAAL 1 : 50

VRAESTEL 1 VRAAG 4.1.2
SACAI NSS EKSAMEN
NASIENRIGLYNE

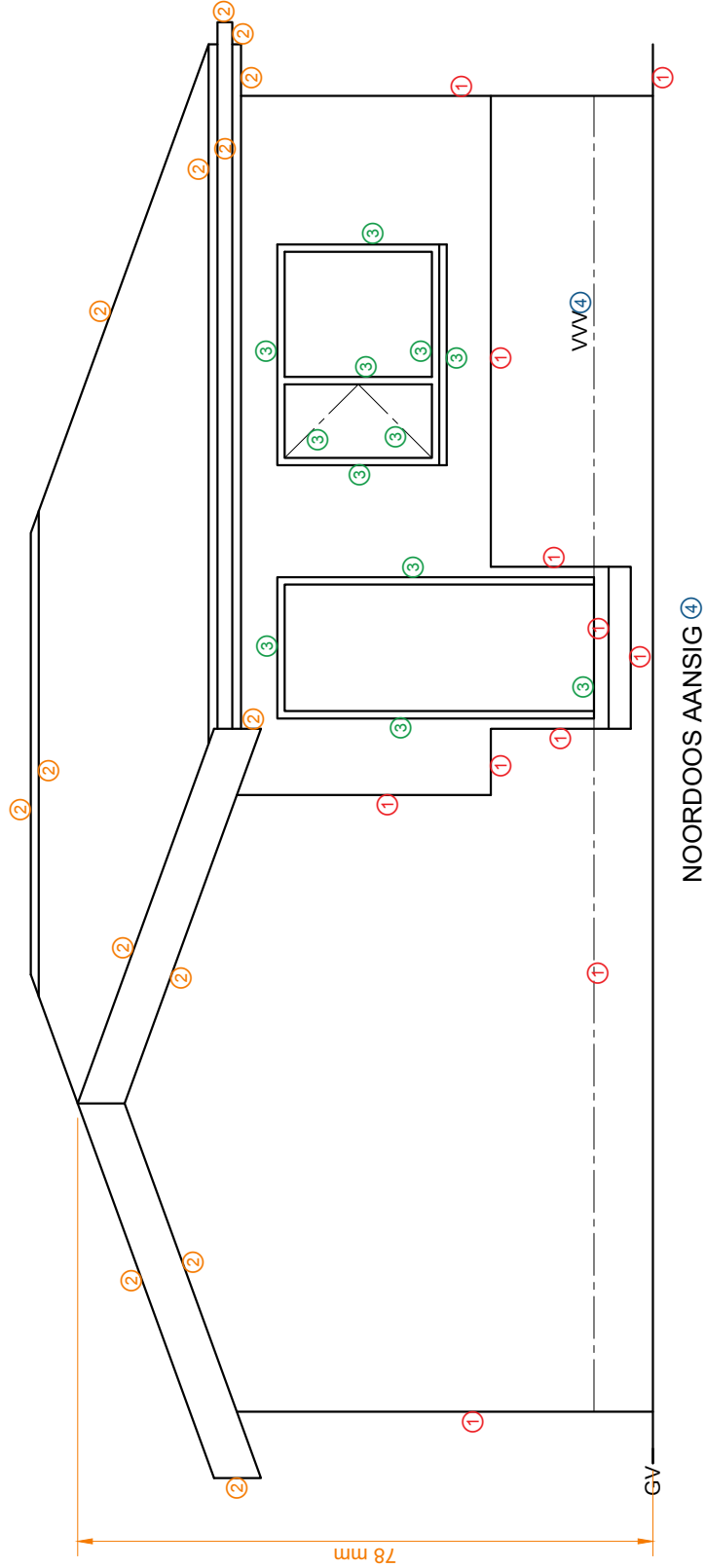

ASSESSERINGSKRITERIA	
NOORDOOS-AANSIG	
1	MURE + VVV 5 1/2
2	DAK BESONDERHEDE 7
3	DEUR + VENSTER 6
4	BYSKRIFTE 1
SUBTOTAAL: 19 1/2	

1-DAK PUNTETOEKENNING

- A. DAKHELLING+DAKBEDEKKING
+DAKLAT+SPASIERING 4
- B. DAKKAP+OORHANG+
FASSIE+GEUT 6
- C. WINDVEER+DAKNOK 3
- D. MUURPLAAT+PLAFONLAT
+PLAFON 2

TOTAAL: 15

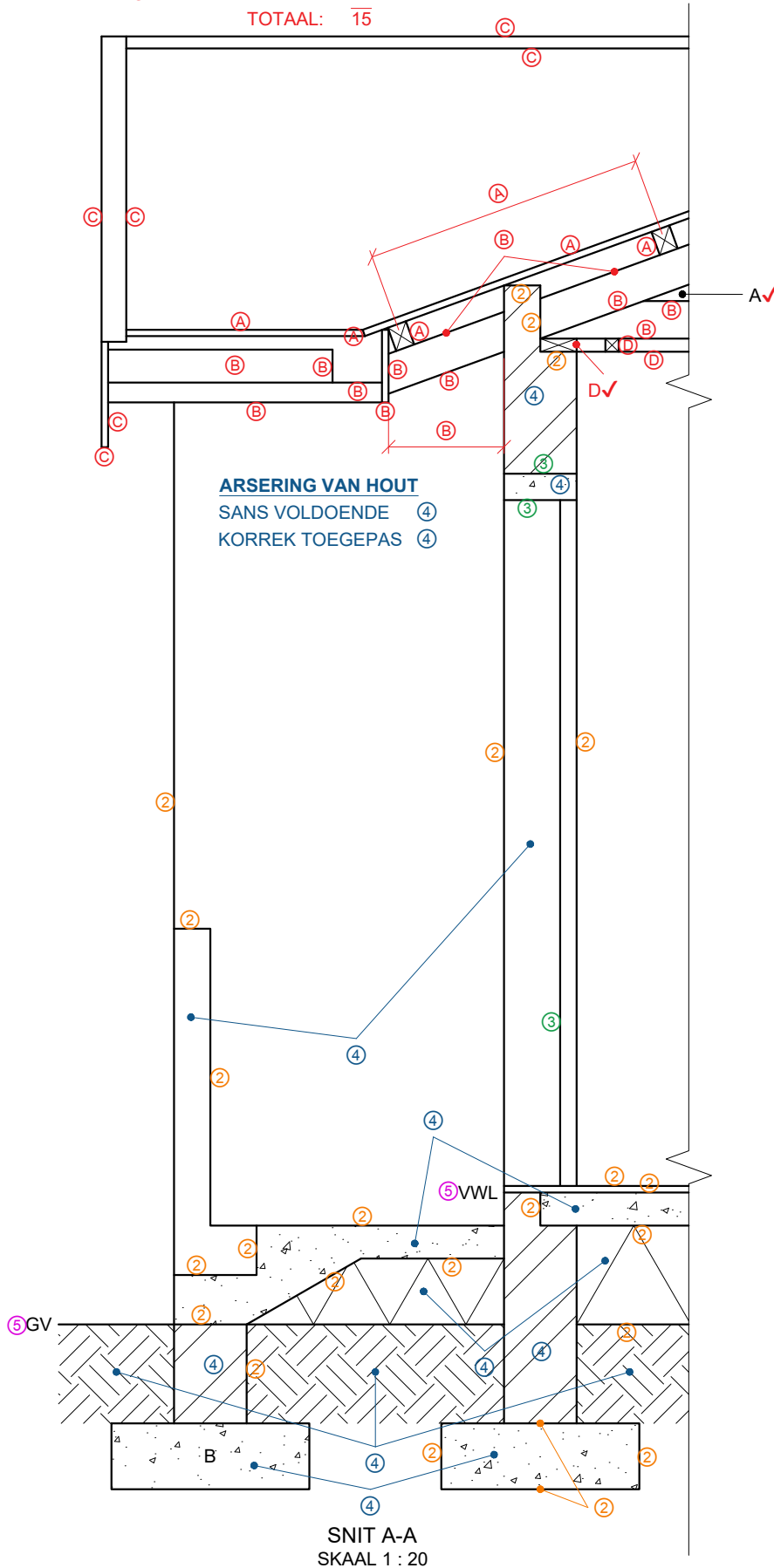

VRAESTEL 1 VRAAG 4.2
SACAI NSS EKSAMEN
NASIENRIGLYNE

ASSESSERINGSKRITERIA		
GEDETAILEERDE SNIT		
1	DAKBESONDERHEDE	15
2	MUUR + BLAD	11 ½
3	DEUR + LATEI	1 ½
4	ARSERING	5 ½
5	BYSKRIFTE	1
SUBTOTAAL:		34 ½